

# Switch Disconnectors with Fuse-Holders SE Series, 2-3-4 Poles, Type B, Panel Mounting



## REGOLUS SWITCH DISCONNECTORS

The Giovenzana Disconnectors Regolus Series, built to the most stringent European and international standards (IEC / EN 60947-3, UL508), meets all the safety requirements.

The long industrial experience combined with the use of the best materials, plant and most modern design tools, enables us to produce a range of high quality equipment placing Giovenzana brand as synonymous of reliability, operational reliability and durability of its products.

## SE SERIES

The disconnectors modular SE Series from 2 to 4 poles, from 32A to 100A allows to install IP20 terminal protections and auxiliary contacts (SE16-SE32 only).

## GENERAL CHARACTERISTICS

- Rated current from 32A to 100A
- Series modular with 4 poles
- Matching with auxiliary contacts

## AVAILABLE VERSIONS

- Panel mounting Screw Fixing
- Panel mounting Ø22,5mm Central Hole Fixing (SE16-SE32 only)
- Base Mounting
- Door locking

## COMPLY WITH RULES

- IEC/EN 60947-3, UL508.
- IEC/EN 60947-5-1, UL508 (auxiliary contacts).

SERIES			SE16 - SE32	SE63 - SE80 SE100	AUXILIARY CONTACTS			
Protection class	control terminals	EN 60529 (UL50 ♦) NEMA 4X EN 60529	IP65 (Type 1 - 4 - 4X) IP20	IP65 (Type 1 - 4 - 4X) IP20	- IP20			
Material Group		EN 60947-1	II	II	II			
Pollution class		EN 60947-1	3	3	3			
Flammability		UL94	VO (Live Electric parts)	VO (Live Electric parts)	VO (Live Electric parts)			
Ambient Temperature		°C	Operating: -25 +55	Operating: -25 +55	Operating: -25 +55			
		°C	Storage: -30 +70	Storage: -30 +70	Storage: -30 +70			
Climate Withstand		IEC 68 part 2-3 IEC 68 part 2-30	Constant Hot Damp Cyclical Hot Damp	Constant Hot Damp Cyclical Hot Damp	Constant Hot Damp Cyclical Hot Damp			
Connections	Terminal Block Caliber	EN60947-1	A6	A8	A2			
	Terminal Screw		M4	M5	M3,5			
	Screwing Torque	EN60947-1	1,2 Nm	3 Nm	0,8 Nm			
		UL508	7 lb. in. (0,8 Nm)	32,0 lb. in. (3,6 Nm)	12 lb. in.			
Connectable Section	Flexible Conductors n°1 min/max	mm <sup>2</sup>	1,5 - 10	6 - 25	1 - 2,5			
		AWG	16 - 8	10 - 2	18 - 12			
	Solid Conductors n°1 min/max	mm <sup>2</sup>	1,5 - 10	10 - 35	1 - 2,5			
		AWG	16 - 8	10 - 2	18 - 12			
Contacts			Slow opening Double-Break	Slow opening Double-Break	Slow opening Double-Break Positive opening for NC ♦			
Opening Angles			90°	90°	-			
Mechanical Lifetime		nr. of cycles	100.000	100.000	1.500.000			
at 120 operations per hour								
Maximum Altitude	Until 2000 mt	Derating	Standard	Standard	-			
	Over 2000 mt	Voltage Derating (V)	< 1% ogni 100 m	< 1% ogni 100 m	-			
		Power Derating (A)	< 1% ogni 1000 m	< 1% ogni 1000 m	-			
CERTIFICATIONS			SE 16	SE 32	SE 63	SE 80	SE 100	AUXILIARY CONTACTS
CE	CE Mark - Europe		■	■	■	■	■	■
cUL	cUL Listed - USA and Canada		●	●	●	●	●	●
IMQ	Istituto Marchio Qualità (IMQ) - Italy		●	●	●	●	●	●
CCC	CCC China		●	●	●	●	●	●
EAC	EAC Russia		●	●	●	●	●	●

# Switch Disconnectors with Fuse-Holders SE Series, 2-3-4 Poles, Type B, Panel Mounting



EN 60947-3 CHARACTERISTICS			SE16	SE32	SE63	SE80	SE100	AUXILIARY CONTACTS
Rated operating voltage Ue	V		690*	690*	690	690	690	690
Rated insulation voltage Ui	V		690*	690*	690	690	690	690
Rated impulse withstand voltage Uimp (sectionable)	kV		4*	4*	8	8	8	4
Rated thermal current Ith	A		(30*) 32	40*	63*	86*	100	16
Rated thermal current in enclosed Ithe	A		(30*) 32	40*	63*	86*	86	10
Frequency	Hz		50	50	50	50	50	50/60
RATED OPERATING CURRENT Ie: alternate current			SE16	SE32	SE63	SE80	SE100	AUXILIARY CONTACTS
<b>AC-21A</b> Switching resistive loads with light overloads	690V	A	(30*) 32	(32*) 40	63*	80*	100	AC-15 240V - 5A
<b>AC-22A</b> Switching mixed resistive and inductive loads at light overloads	500V	A	-	-	-	-	100	DC-13
	690V	A	(20*) 25	32*	63*	80*	86	250V - 0,44A
<b>AC-23A</b> Periodic switching of motors 3 phases - 3 poles	230V	A/kW	25/7,5	32/10	50/15	63/18,5	70/22	-
	400V	A/kW	25/15	32/18,5	50/30	60/33	67/37	-
	500V	A/kW	25/15	32/22	50/37	60/40	67/45	-
	690V	A/kW	(16*)20/18,5	25*/22	32/30	35/33	38/37	-
<b>AC3</b> Starting of cage motors (interruption hile running) 3 phases - 3 poles	230V	A/kW	22/7,5	30/9	40/11	50/15	60/18,5	-
	400V	A/kW	22/11	30/15	40/22	50/25	55/30	-
	500V	A/kW	22/11	30/18,5	40/30	50/33	55/37	-
	690V	A/kW	(12*)22/11	(20*)22/18,5	25/22	27/25	32/30	-
Nominal interruption power <b>AC-23A</b> (cosfi 0,45)	230V	A	200	256	400	504	560	-
	400V	A	200	256	400	480	536	-
	500V	A	200	256	400	480	536	-
	690V	A	160	200	256	280	304	-
SHORT CIRCUIT CHARACTERISTICS			SE16	SE32	SE63	SE80	SE100	AUXILIARY CONTACTS
Rated short-time short circuit withstand current Icw (1 s)	A		400*	400*	1500	1500	1500	-
Rated short circuit making capacity Icm	A		1500*	1500*	2840	2840	2840	-
Conditional rated short circuit withstand current	kA		10*	10*	10*	10*	10	1
Fuse rating gG	500V	A	-	-	-	-	100	10
	690V	A	40*	40*	(80*)63	(80*)	-	-
UL 508 CHARACTERISTICS			SE16	SE32	SE63	SE80	SE100	CONTATTI AUSILIARI
General Use	600V AC	A	32	40	63	80	100	HD A600 AC Q600 DC
Standard motor load single phase - 2 poles	120V AC	HP (FLA)	1,5 (20)	2 (24)	3 (34)	3 (34)	3 (34)	-
	200-208V AC	HP	2	3	-	-	-	-
	240V AC	HP (FLA)	3 (17)	5 (28)	7,5 (40)	7,5 (40)	10 (50)	-
Standard motor load 3 phases - 3 poles	200-208V AC	HP	7,5	10	-	-	-	-
	240V AC	HP (FLA)	7,5 (22)	10 (28)	10 (28)	10 (28)	10 (28)	-
	480V AC	HP (FLA)	10 (14)	15 (21)	20 (27)	25 (34)	25 (34)	-
	600V AC	HP (FLA)	15 (17)	20 (22)	25 (27)	30 (32)	30 (32)	-

# Switch Disconnectors with Fuse-Holders SE Series, 2-3-4 Poles, Type B, Panel Mounting

## TYPE B Box







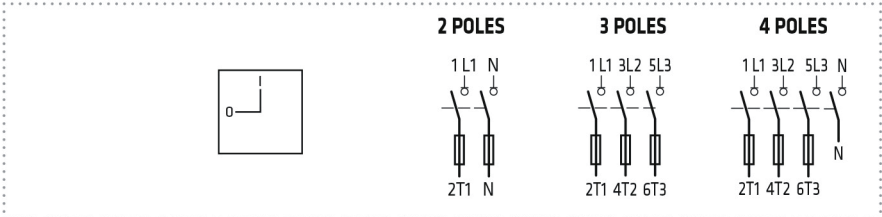

- Fixing box DIN RAIL DIN-EN 50022-35.
- Suitable for Door locking actuators.
- Sectionable fuses-holders.
- For cylindrical fuses 10,3x38 mm UL.

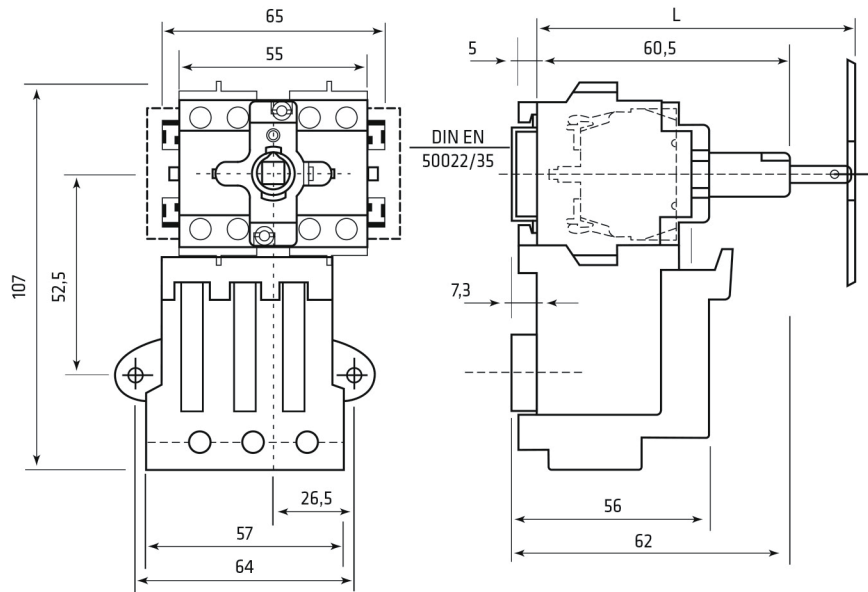
SERIE	AC-21A	UL USO GEN.	CODE		
	AMP. 690V	AMP. 600V	2 POLES	3 POLES	4 POLES
FS20	25	20	FS2010F2B	FS203003B	FS203004B
FS30	32	30	FS3010F2B	FS303003B	FS303004B

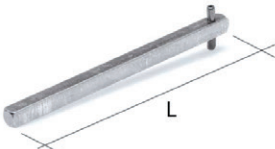

	STANDARD SHAFT	EXTENSION SHAFT □5 CODE 20401089
L min	80	80 (with cut shaft)
L max	120	220



<p><b>BOX FIXING PLATE</b></p>  <p><b>SE16 - SE32</b></p> <p>11814005</p>	<p><b>BOX SHAFT BF1/1NGO</b></p>  <p><b>SE16 - SE32</b></p> <p>11706237</p>												
<p><b>SHAFT EXTENSION FOR DOOR INTERLOCK</b></p>  <table border="1"> <thead> <tr> <th></th> <th>□5</th> <th>□6</th> </tr> </thead> <tbody> <tr> <td></td> <td><b>SE16 - SE32</b></td> <td><b>SE63 - SE80 SE100</b></td> </tr> <tr> <td>L 185 mm</td> <td>20401089</td> <td>20900010</td> </tr> <tr> <td>L 300 mm</td> <td>20401164</td> <td>20900011</td> </tr> </tbody> </table>		□5	□6		<b>SE16 - SE32</b>	<b>SE63 - SE80 SE100</b>	L 185 mm	20401089	20900010	L 300 mm	20401164	20900011	<p><b>TERMINAL PROTECTION</b></p>  <p>2 pieces</p> <p><b>SE63 - SE80 - SE100 / 4 poles Box &amp; Panel Mounting</b></p> <p>20900003</p>
	□5	□6											
	<b>SE16 - SE32</b>	<b>SE63 - SE80 SE100</b>											
L 185 mm	20401089	20900010											
L 300 mm	20401164	20900011											
<p><b>AUXILIARY CONTACTS</b></p>  <table border="1"> <thead> <tr> <th colspan="2"><b>SE16 - SE32</b></th> </tr> <tr> <th>CODE</th> <th>DIAGRAM</th> </tr> </thead> <tbody> <tr> <td>PL004001</td> <td>1NC 1 — 2</td> </tr> <tr> <td>PL004002</td> <td>1NO 3 — 4</td> </tr> </tbody> </table>	<b>SE16 - SE32</b>		CODE	DIAGRAM	PL004001	1NC 1 — 2	PL004002	1NO 3 — 4	<p><b>AUXILIARY CONTACTS FIXING PLATE</b></p>  <p><b>SE16 - SE32</b></p> <p>11814021</p> <p>The sale of these two accessories is matched for the correct use of the product.</p>				
<b>SE16 - SE32</b>													
CODE	DIAGRAM												
PL004001	1NC 1 — 2												
PL004002	1NO 3 — 4												